

Table of Contents

Usage Notice

<i>Precautions</i>	2
--------------------------	---

Introduction

<i>Product Features</i>	4
<i>Package Overview</i>	5
<i>Product Overview</i>	6
<i>Main Unit</i>	6
<i>Control Panel</i>	7
<i>Connection Ports</i>	8
<i>Wireless Remote Control</i>	9

Installation

<i>Connecting the Projector</i>	10
<i>Powering On/Off the Projector</i>	11
<i>Powering On the Projector</i>	11
<i>Powering Off the Projector</i>	12
<i>Adjusting the Projected Image</i>	13
<i>Adjusting the Projector's Height</i>	13
<i>Adjusting the Projector's Zoom/Focus</i>	14

User Controls











<i>Control Panel & Remote Control</i>	15
<i>Onscreen Display Menus</i>	18
<i>How to Operate</i>	18
<i>Menu Tree</i>	19
<i>Picture</i>	20
<i>Image</i>	22
<i>System</i>	24
<i>Display</i>	25

Appendices

<i>Troubleshooting</i>	27
<i>Replacing the Lamp</i>	30
<i>Ceiling Mount Installation</i>	31

Precautions

Please follow all warnings, precautions, and maintenance procedures as recommended in this user's guide.

-  **Warning-** Do not look into the lens. The bright light may cause eye injury.
-  **Warning-** To reduce the risk of fire or electric shock, do not expose this product to rain or moisture.
-  **Warning-** To prevent the risk of electric shock, do not open or disassemble the product.
-  **Warning-** Please allow the unit to cool down before changing the lamp; carefully follow the lamp replacement instructions listed under "Replacing the lamp."
-  **Warning-** This product self-detects the life cycle of the lamp and will display a warning message when the lamp is about to expire. Be sure to replace the lamp when it displays warning messages.
-  **Warning-** After installing a new lamp, reset the lamp life using the onscreen menu.
-  **Warning-** Before turning off the product, follow the cooling fan to run for several minutes.
-  **Warning-** Turn on the projector first and then select the signal sources.
-  **Warning-** Do not use lens cap when projector is in operation.
-  **Warning-** When the lamp reaches the end of its life, it will burn out and may make a loud "popping" sound. If this occurs, the projector will not turn back on until the lamp module has been replaced. To replace the lamp, follow the procedures listed under "Replacing the Lamp."

Usage Notice

Do:

- ❖ Turn off the product before cleaning.
- ❖ Use a soft cloth moistened with mild detergent to clean the display housing.
- ❖ Disconnect the power plug from AC outlet if the product is not being used for a long period of time.

Do not:

- ❖ Block the slots and openings on the unit provided for ventilation.
- ❖ Place the unit under direct sunlight.
- ❖ Use abrasive cleaners, waxes or solvents to clean the unit.
- ❖ Use under the following conditions:
 - Extremely heat, cold or humidity.
 - In areas susceptible to excessive dust and dirt.
 - Near any appliance generating a strong magnetic field.

Product Features

This product is a WXGA single chip 0.79-inch DLP™ projector featuring:

- ◆ True WXGA resolution 1280 x 720 addressable pixels
- ◆ Single chip DLP™ technology
- ◆ Power zoom and focus
- ◆ HDTV compatible (480i/p, 576i/p, 720p, 1080i)
- ◆ NTSC/PAL/SECAM, and HDTV compatible
- ◆ Hi-tech DVI-I connection for digital and analog video connectivity
- ◆ IR remote control
- ◆ User-friendly multilingual onscreen display menu
- ◆ Advanced electronic keystone correction
- ◆ User-friendly control panel
- ◆ SXGA compression
- ◆ Vertical lens shift
- ◆ HDCP compliant

Package Overview

This projector comes with all the items shown below. Check to make sure your unit is complete.



Projector Unit



Power Cord



RS232 Cable 1.8m



Composite Video Cable
1.8m



S-Video Cable 1.8m



IR Remote Control



User's Manual/
Warranty Card



Battery x 2



SCART RGB Adaptor
(For European Use
Only)



- ❖ Due to the difference in applications for each country, some regions may have different accessories.

Introduction

Product Overview

Main Unit

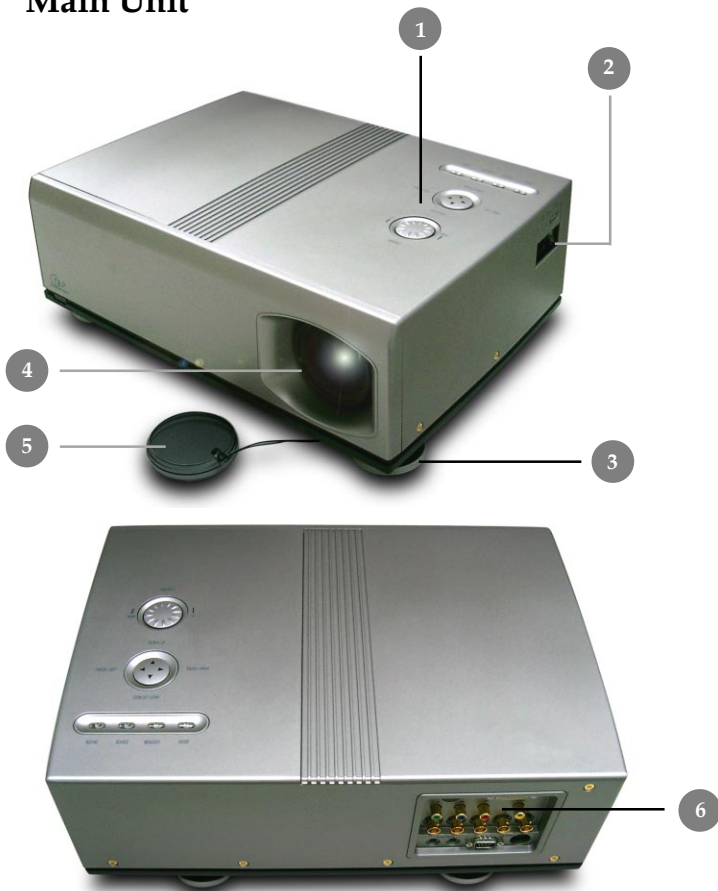

1. Control Panel
2. Power Socket & Main Power Switch
3. Four Adjustable Feet
4. Lens
5. Lens Cap
6. Connection Ports

Control Panel

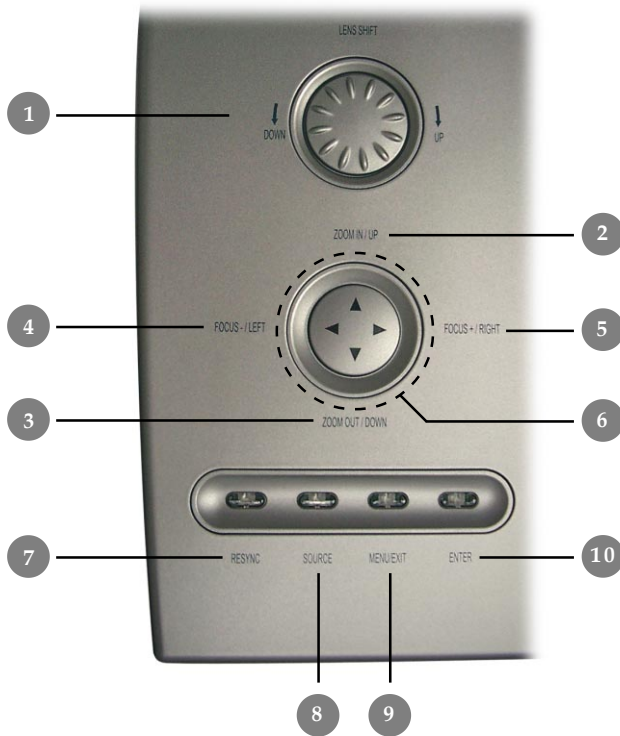

1. Lens Shift (Up/Down)
2. Optics Zoom In/Up
3. Optics Zoom Out/Down
4. Optics Focus -/Left
5. Optics Focus +/Right
6. Four Directional Select Keys
7. Resync
8. Source
9. Menu/Exit
10. Enter

Introduction

Connection Ports



1. Lamp LED
2. Temp LED
3. Power LED
4. Power Socket
5. Main Power Switch
6. IR Receiver
7. RCA YPbPr Connectors
8. BNC YPbPr/RGBHV Connectors
9. +12V Relay Connectors
10. RS-232 Connector
11. S-Video Input Connector
12. Composite Video Input Connector
13. DVI-I Input Connector

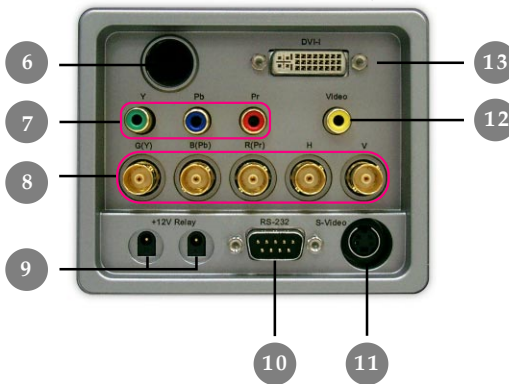

Wireless Remote Control

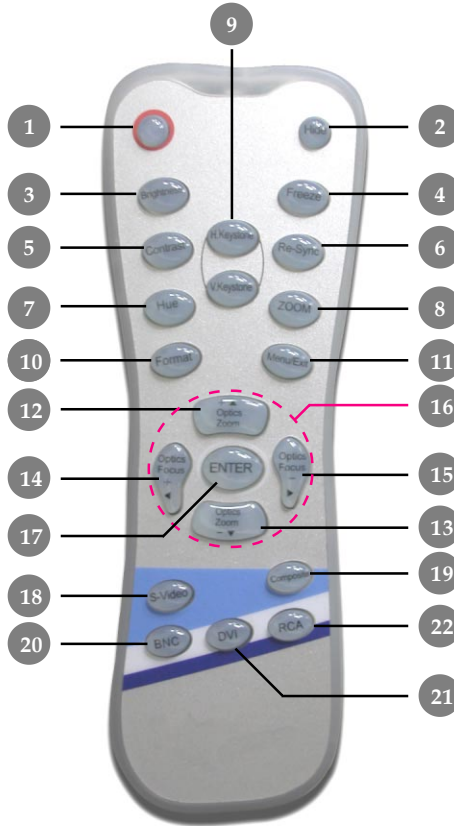

- | | |
|------------------------|----------------------------------|
| 1. Power On/Off | 13. Optics Zoom Out/Down |
| 2. Display Hide | 14. Optics Focus +/Left |
| 3. Brightness | 15. Optics Focus -/Right |
| 4. Freeze | 16. Four Directional Select Keys |
| 5. Contrast | 17. Enter |
| 6. Re-sync | 18. S-Video Source |
| 7. Hue Adjustment | 19. Composite Source |
| 8. Electronic Zoom | 20. BNC Source |
| 9. Keystone Adjustment | 21. DVI-I Source |
| 10. Format | 22. Component Source (YPbPr) |
| 11. Menu/Exit | |
| 12. Optics Zoom In/Up | |

Installation

Connecting the Projector

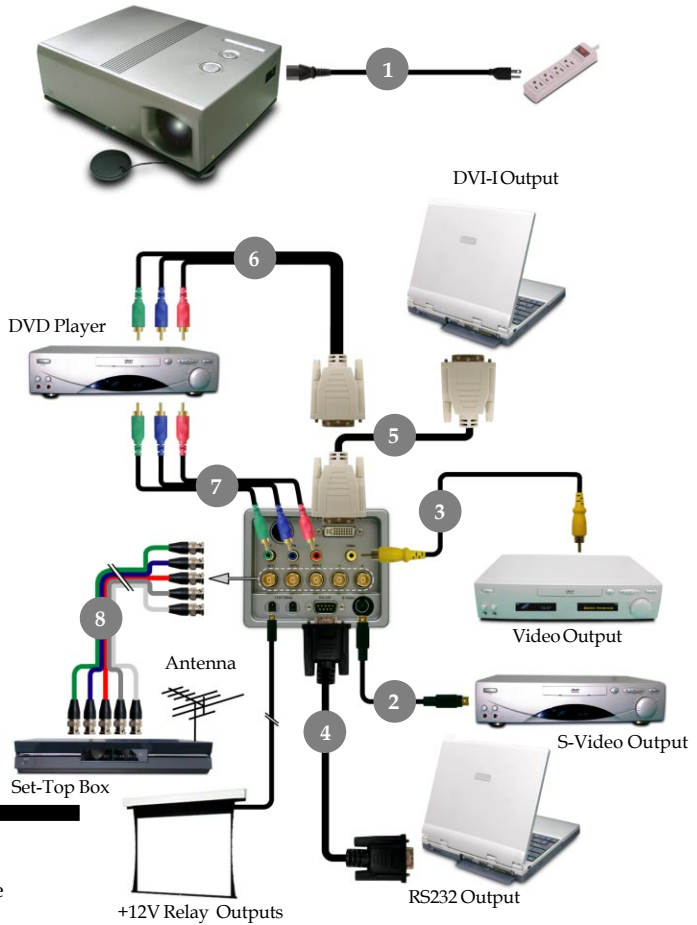

1. Power Cord
2. S-Video Cable
3. Composite Video Cable
4. RS232 Cable
5. DVI to DVI Cable (Optional)
6. DVI to RCA Cable for YPbPr (Optional)
7. RCA Component Cable for YPbPr (Optional)
8. BNC Cable for RGB/Component (Optional)

❖ *To ensure that the projector properly displays source material from your computer, please configure the display settings of your graphics card to less than or equal to 1280 x 720 resolution. Be sure that the timing of the display setting is compatible with the projector.*

Powering On/Off the Projector

Powering On the Projector

1. Remove the lens cap. ❶
2. Ensure that the power cord and signal cable are securely connected.
3. Turn on the lamp by pressing the “Power” button on the side of the projector. ❷

The startup screen will display in approximately one minute.

4. Turn on your source (computer, notebook, video player etc), the projector will automatically detect your source.
- ❖ If the screen displays “No Signal,” make sure the signal cables are securely connected.
 - ❖ If you connect multiple sources at the same time, use the “Source” button on the remote control or control panel to select your desired source.



- ❖ Turn on the projector first and the signal sources next.



Powering Off the Projector

1. Press the “Power” button to turn off the projector lamp.
 2. After pressing the “Power” button, you will see the message “Power off the lamp? Video Mute” displayed on the projector’s screen. Press the “Power” button again to confirm, otherwise the message will disappear after five seconds.
Please note that if the  key is pressed instead, the projector will enter the “Video Mute” mode and no image will be displayed. To exit the “Video Mute” mode, press the “Power” button again.
 3. The “Power” LED indicator will flash for about 120 seconds while the lamp cools. After the “Power” indicator stops flashing, you may then turn off the main power switch on the side of the projector. If you want to turn on the projector, you must press “Power” within 90 seconds of when the “Power” indicator begins to light on.
 4. Do not restart the projector immediately following a power off procedure.
- ❖ *If the “TEMP” indicator flashes orange for approximately ten seconds, the projector will display “Fan Fail.” Please contact your local reseller or service center.*
 - ❖ *If the “TEMP” indicator illuminates orange, the projector has overheated. The projector will display “Over Temperature.” The projector will then automatically shut down. After cool down, under normal conditional, user can press the “Power” button to turn on the unit again. However, if the problem persists, you should contact your local reseller or service center.*
 - ❖ *If the “LAMP” indicator illuminates red, the lamp may of failed. Please contact your local reseller or service center.*

Adjusting the Projected Image

Adjusting the Projector's Height

The projector is equipped with four adjustable feet to modify the height of the projector.

To raise or lower the projector :

1. Locate the adjustable foot you wish to modify on the under side of the projector.
2. Rotate the adjustable foot counterclockwise to raise the projector or clockwise to lower it. Repeat with the remaining feet as needed.
3. Reset the projector on its feet and re-adjust as needed.



Four Adjustable feet

Installation

Adjusting the Projector's Zoom/Focus

You may adjust the projected image size by pressing the Zoom buttons. Press ▲ to zoom in or ▼ to zoom out. To adjust focus of an image, press the focus shift buttons ◀ and ▶. The projector will focus at distances from 3.3 to 32.8 feet (1.0 to 10.0m).

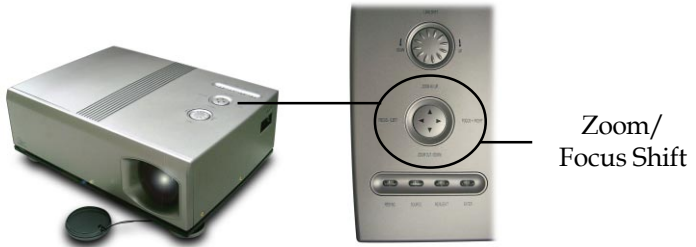

Control Panel & Remote Control

There are two ways for you to control the functions: with control panel and remote control.

Control Panel



Remote Control



Using the Remote Control

Power

- ▶ "Power" turns on the projector's lamp, refer to the "Powering On/Off the Projector" section on page 11~ 12 for more details.

Hide

- ▶ "Hide" immediately turns the screen black. Press "Hide" a second time to restore the display.

Brightness

- ▶ Adjust the brightness of the image.

Freeze

- ▶ Press "Freeze" to pause the screen image.

User Controls

Contrast

- ▶ “Contrast” controls the degree of difference between the lightest and darkest parts of the picture.

Hue

- ▶ “Hue” adjusts the color balance from red to green.

H.Keystone & V.Keystone

- ▶ Correct image distortion caused by rotating and tilting the projector.

Re-Sync

- ▶ Automatically synchronizes the projector to the input source.

Zoom

- ▶ Press “Zoom” to display the zoom menu.
Press ▲ or ▼ button to zoom in or zoom out of an image.

Format

- ▶ Display the “Format” section of the onscreen display menu to select the desired aspect ratio.

Menu/Exit

- ▶ Display or exits the onscreen display menu.

Optics Zoom In/Optics Zoom Out

- ▶ Press ▲ or ▼ button to zoom the lens in or zoom out.

Optics Focus Right/Optics Focus Left

- ▶ Press ► or ◀ button to focus the image.

Four Directional Select Keys

- ▶ Press “Menu/Exit” then use ▲ ▼ ◀ ► to select items or make adjustments to your selection.

Enter

- ▶ Confirm your item selection.

S-Video

- ▶ Press “S-Video” to choose S-Video source.

Composite

- ▶ Press “Composite” to choose video source.

BNC

- ▶ Press “BNC” to choose Analog RGB or YPbPr video from the BNC input.

DVI

- ▶ Press “DVI” to select input from the DVI-I connector

RCA

- ▶ Press “RCA” to select input from the RCA component video connector.

Using the Control Panel

Power

- ▶ The power switch is located near the power socket on the side of the projector. Use it to power on/off the projector. Please refer to the “Powering On/Off the Projector” section on pages 11~ 12.

Lens Shift

- ▶ Turn the Lens Shift dial clockwise to shift the projected image in an up ward direction. Turn the Lens Shift dial counter clockwise to shift the projected image in a down ward direction.

Optics Zoom In/Optics Zoom Out

- ▶ Press ▲ or ▼ button to zoom the lens in or zoom out.

Optics Focus Right/Optics Focus Left

- ▶ Press ► or ◀ button to focus the image.

Four Directional Select Keys

- ▶ Press “Menu/Exit” then use ▲ ▼ ◀ ► to select items or make adjustments to your selection.

Re-Sync

- ▶ Automatically synchronizes the projector to the input source.

Source

- ▶ Press “Source” to choose RGB, DVI-Digital, DVI-Analog, S-Video, Composite, Component, and HDTV sources.

Menu/Exit

- ▶ Display or exit the the onscreen display menus.

Enter

- ▶ Confirm your selection.

Onscreen Display Menus

How to Operate

- ▶ The projector has multilingual onscreen display menus that allow you to make image adjustments and change a variety of settings. The projector automatically detects the source.
- ▶ To launch the menu, press “Menu/Exit” on the Remote Control or Control Panel.
- ▶ When the main menu is displayed, use ▲ ▼ ◀ ▶ to select it. While making a selection, press “Enter” to go into the sub-menu.
 - ◆ To exit the menu, press “Menu/Exit”.
- ▶ When a sub-menu is displayed, use ▲ ▼ to select the desired item and adjust the settings with ◀ ▶.
 - ◆ To exit the sub-menu, press “Menu/Exit”.
- ▶ After using ◀ ▶ to make selections to the sub-menu, press “Enter” to confirm your changes and return to the main menu.
 - ◆ Press “Menu/Exit” to return to the main menu. If you don’t press “Enter” to confirm your changes and exit the menu, the items will not be modified.

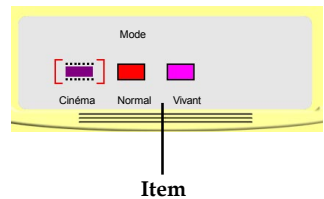
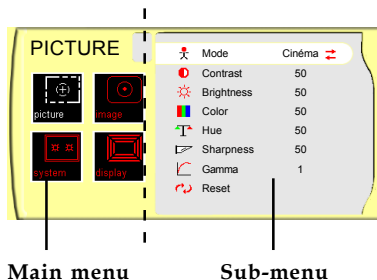

Menu Tree

PICTURE.....	Mode	Cinema/Normal/Vivid
	Contrast	
	Brightness	
	Color (Video only)	
	Hue (Video only)	
	Sharpness	
	Gamma	
	Reset	Current/All
IMAGE.....	White Peaking	1/2/3
	Color Temp	Film/Video/TV
	Image Mode	R Contrast/G Contrast/B Contrast/R Brightness/G Brightness/ B Brightness
	Advanced Adjustment	
	Signal	Horizontal/Vertical/Frequency/ Phase
	Reset	Current/All
SYSTEM.....	Language	English/French/Japanese/Spanish/ Chinese Simplified/Chinese Traditional/Italian/Portugese/ Germany/Korean
	Bulb	Lamp Hour/Lamp Reminding/Lamp Hour Reset
	Source Lock	On/Off
	Auto Shutdown	On/Off
	Blanking	Blue/Black
	Eco Mode	On/Off
	Color Space	Auto/RGB/YUV
DISPLAY.....	Projection	Front Desktop/Front Ceiling/Rear Desktop/Rear Ceiling
	Format	
	Vertical Shift	Native/Window/16:9/Letter Box
	H.Keystone	
	V.Keystone	-50~+50
	Digital Zoom	+1~32

User Controls

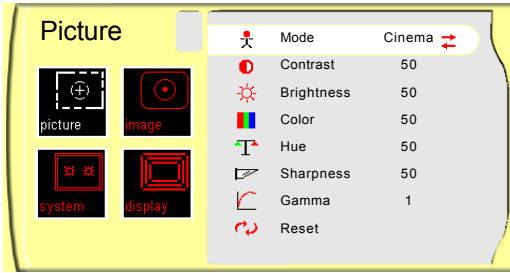

PICTURE

Mode

There are three factory presets optimized for various types of pictures: Cinema, Normal, and Vivid. You can customize contrast, brightness, intensity, color, tint, sharpness, and gamma for each preset mode.

Contrast

Contrast controls the degree of difference between the lightest and darkest parts of the picture. Adjusting the contrast changes the amount of black and white with an image.

- ▶ Press ◀ to decrease the contrast.
- ▶ Press ▶ to increase the contrast.

Brightness

Adjust the brightness of the image.

- ▶ Press ◀ to darken an image.
- ▶ Press ▶ to lighten an image.

Color

Adjust a video image from black and white to fully saturated color.

- ▶ Press ◀ to decrease the amount of color in an image.
- ▶ Press ▶ to increase the amount of color in an image.

Hue

Adjust the color balance of red and green.

- ▶ Press ◀ to increase the amount of green in an image.
- ▶ Press ▶ to increase the amount of red in an image.

Sharpness

Adjust the sharpness of an image.

- ▶ Press ◀ to decrease the sharpness.
- ▶ Press ▶ to increase the sharpness.



- ❖ The “Color” sub menu is not supported under the digital RGB input source.
- ❖ The “Hue” sub menu is not supported under the digital RGB, component video or analog RGB input sources.

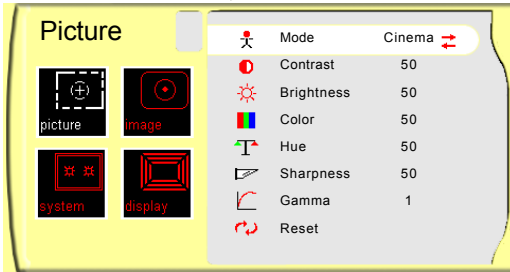

PICTURE

Gamma

Gamma affects how dark scenery is displayed. With a greater gamma value, dark scenery will appear brighter. Use ◀ ▶ to adjust gamma values.

Reset

Return the adjustments and settings to factory default values.

- ▶ Current: Returns the current menu's settings to factory default values.
- ▶ All: Returns the settings for all menus to factory default values.

User Controls

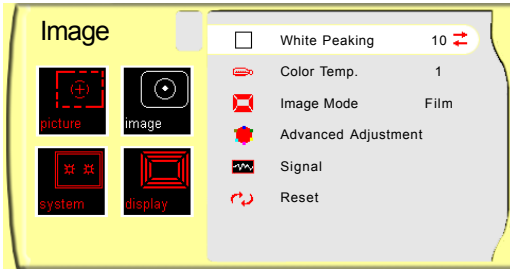

IMAGE

White Peaking

Use the white peaking control to set the white peaking level of the DMD chip. “0” stands for minimal peaking, and “10” stands for maximum peaking. If you prefer a stronger image, adjust toward the maximum setting. For a smoother, more natural image, adjust toward the minimum setting.

Color Temp

Adjust the color temperature. The range is from “1” to “3.” At a higher temperature, the screen looks colder; at a lower temperature, the screen looks warmer.

Image Mode

There are three factory presets optimized for various types of images:

- ▶ Film : For home theater
- ▶ Video : For video mode
- ▶ TV : For TV

Advanced Adjustment

Use ◀ or ▶ to select R (Red), G (Green), or B (Blue) for brightness and contrast.

Signal

- ▶ Horizontal: Adjusts the horizontal position.
- ▶ Vertical: Adjusts the vertical position.
- ▶ Frequency: Changes the display data frequency to match the frequency of your computer’s graphic card. When you experience a vertical flickering bar, use this function to make an adjustment.
- ▶ Phase : Synchronizes the signal timing of the display with the graphics card. If you experience an unstable or flickering image, use this function to correct it.



❖ The “Signal” sub menu is supported under the Analog RGB and Analog YPbPr input sources.

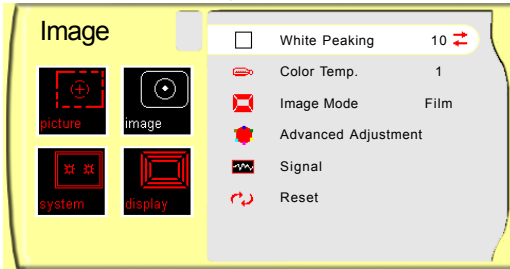

IMAGE

Reset

Return the adjustments and settings to factory default values.

- ▶ Current: Return the current menu's settings to factory default values.
- ▶ All: Return all menu settings to factory default values.

User Controls

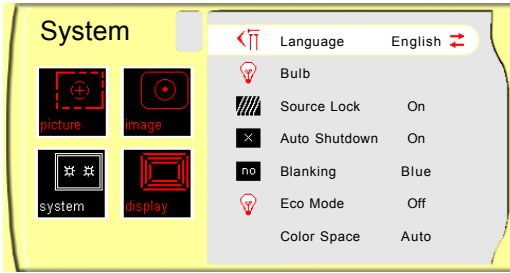

SYSTEM

Language

Display a multilingual menu. Use ◀ and ▶ to select your preferred language.

Bulb

- ▶ Lamp Hour: Display the cumulative lamp operating time.
- ▶ Lamp Reminding: Select this function to show or hide the warning message when the lamp replacing reminder message is displayed. The message will show up when the lamp reaches 1500 hours at normal mode.
- ▶ Lamp Hour Reset: Reset the lamp life hour after replacing a new lamp.

Source Lock

When source lock is turned off, the projector will search for other signals if the current input signal is lost. When source lock is turned on, it will continue to search for the “lost signal” after “Source” is pressed.

Auto Shutdown

Determine the time interval to shutdown the system if there is no signal input. Select “On” in the Auto Shutdown menu to turn the projector off automatically.

Blanking

Use this feature to display a black or blue screen when there is no signal is available.

Eco Mode

This is also known as “Economy Mode.” Selecting “On” decreases the fan noise from the projector as well as enhancing the black level and reducing the brightness. You may find this is the best mode for watching movies.

Color Space

Select an appropriate color matrix type from Auto, RGB or YUV (YPbPr).

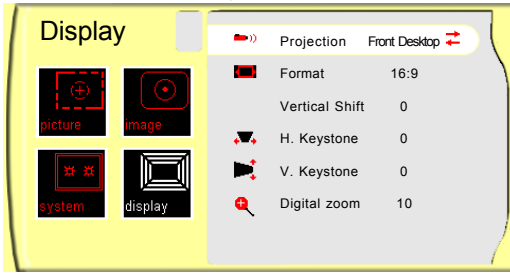

DISPLAY

Projection

▶  **Front-Desktop**

The factory default setting.

▶  **Rear-Desktop**

When you select this function, the projector reverses the image so you can project from behind a translucent screen.

▶  **Front-Ceiling**

When you select this function, the projector turns the image upside down for ceiling-mounted projection.

▶  **Rear-Ceiling**

When you select this function, the projector reverses and inverts the image at same time. Using this setting enables you to project from behind a translucent screen with ceiling mounted projection.

Vertical Shift

Adjust the lens offset by shifting the projected image position vertically.

- A** Normal Range
- B** -100% Lens Shift
- C** +100% Lens Shift

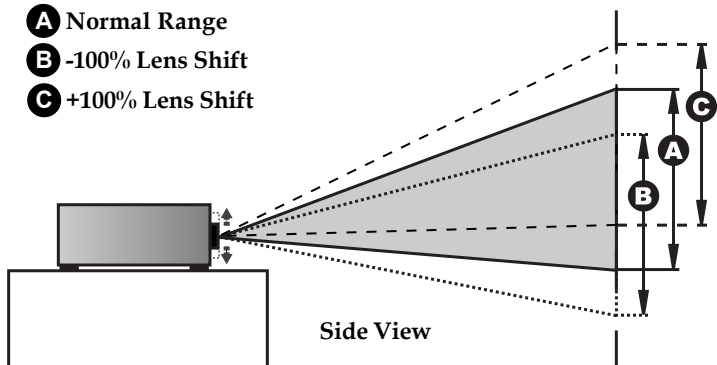

User Controls

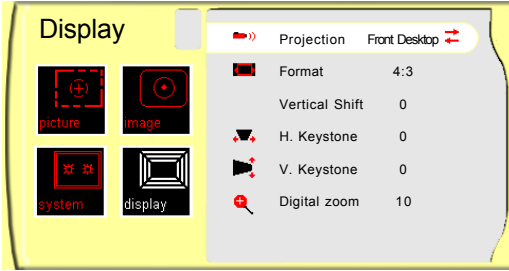

DISPLAY

Format

- ▶ Native: Original image size.
- ▶ 16:9: The standard widescreen display format of the projector.
- ▶ Letterbox: Letterbox mode zooms a letterboxed image intended for 4:3 display to full screen wide.



Original Input



The letterbox

- ▶ Window: When a 4:3 image is bigger than a 16:9 screen, select the “Window” mode to fit the image onto the screen without changing the projection distance.



Original Input



Window

H. Keystone

Correct image distortion caused by rotating the projector horizontally.

V. Keystone

Correct image distortion caused by tilting the projector vertically.

Digital Zoom

Provide different magnification ratios to zoom an image. Images will be centered after zooming.

Troubleshooting

If you experience a problem with your projector, please refer to the following information. If a problem persists, please contact your local reseller or service center.

Problem: No image appears on screen.

- ▶ Ensure that all the cables and power cord are correctly and securely connected as described in the “Installation” section.
- ▶ Ensure that connector pins are not bent or broken.
- ▶ Make sure that the projection lamp has been securely installed. Please refer to the “Replacing the lamp” section.
- ▶ Ensure that you have removed the lens cap and that the projector is turned on.
- ▶ Ensure that the “Hide” feature is not enabled.

Problem: Partial, scrolling, or incorrectly displayed images.

- ▶ Press “Re-Sync” on the remote control or control panel.
- ▶ If using a PC:

For Windows 3.x:

1. In the Windows Program Manager, double click the “Windows Setup” icon in the Main group.
2. Verify that your display resolution setting is less than or equal to 1280 x 720.

For Windows 95, 98, 2000, XP:

1. Open the “My Computer” icon. Next, open the “Control Panel” folder, and double click the “Display” icon.
2. Select the “Settings” tab.
3. (Above in “Windows 3.x”). Click on the “Advanced Properties” button. Verify that your display resolution setting is less than or equal to 1280 x 720.

If the projector is still not projecting the image, you may need to adjust your monitor display setting. To do this, please refer to the following instructions.

4. Verify the resolution is less than or equal to 1280 x 720.
 5. Select the “Change” button under the “Monitor” tab .
 6. Click on “Show all devices.” Next, select “Standard monitor types” under the SP box; choose the resolution mode you need under the “Models” box.
 7. Verify that the resolution setting of the monitor display is less than or equal to 1280 x 720.
- ▶ If using a Notebook PC:
 1. First, follow the steps above to adjust resolution of the computer.
 2. Switch the Notebook PC display to the “external display only” or “CRT only” mode.
 - ▶ If you experience difficulty changing resolutions or your monitor freezes, restart all the equipment including the projector.

Problem: The screen of the Notebook or PowerBook computer is not displaying your presentation.

▶ **If using a Notebook PC:**

Some Notebook PCs may deactivate their own screens when a second display device is in use. Each has a different way of reactivating. Refer to your computer’s documentation for detailed information.

Problem: Image is unstable or flickering

- ▶ Use “Phase” to correct it. See page 22 for more information.
- ▶ Change the monitor color setting on your computer.

Problem: Image has a vertical flickering bar

- ▶ Use “Frequency” to make an adjustment. See page 22 for more information.
- ▶ Check and reconfigure the display mode of your graphics card to ensure compatibility.

Problem: Image is out of focus

- ▶ Make sure the transparent lens cap is removed.
- ▶ Use ◀ or ▶ button to focus the image.
- ▶ Make sure the projection screen is between the required distance 3.3 to 32.8 feet (1.0 to 10.0 meters) from the projector.

Problem: Image is reversed.

- ▶ Press “Menu” button then select “Display” to adjust the projection.

Problem: Lamp burns out or makes a popping sound

- ▶ When the lamp reaches its end of life, it will burn out and may make a loud popping sound. If this happens, the projector will not turn on until the lamp module has been replaced. To replace the lamp, follow the procedures in the “Replacing the Lamp” section on page 30.

Problem: LED lighting message

Message	Power LED (Blue)	Temp LED (Orange)	Lamp LED (Red)
Standby State (Input power cord)	Off	Off	Off
Power on	On	Off	Off
Power off	Flashing	Off	Off
Error (Lamp fail)	Flashing	Off	On
Error (Thermal switch)	Flashing	On	Off
Error (Thermal Pre-cooling)	Off	Flashing	Off
Error (Fan lock fail)	Flashing	Flashing	Off
Error (Over Temp.)	Off	On	On
Error (Lamp Breakdown)	Flashing	Off	On

Problem: Message Reminders

- ▶ “Lamp may fail soon! Replacement suggested!” will be shown about 10 seconds when lamp life is going to deplete.
- ▶ “Over Temperature” will be shown momentarily before shutdown if system temperature is too high.
- ▶ “Fan Fail” will be shown momentarily before shutdown if fan is out of order.

Replacing the Lamp

The projector displays a warning message "Lamp may fail soon ! Replacement Suggested !" When you see this message, please contact your local reseller or service center.

Make sure the projector has cooled down for at least 30 minutes before changing the lamp.



Warning:

Lamp compartment is hot! Allow it to cool down before changing lamp!

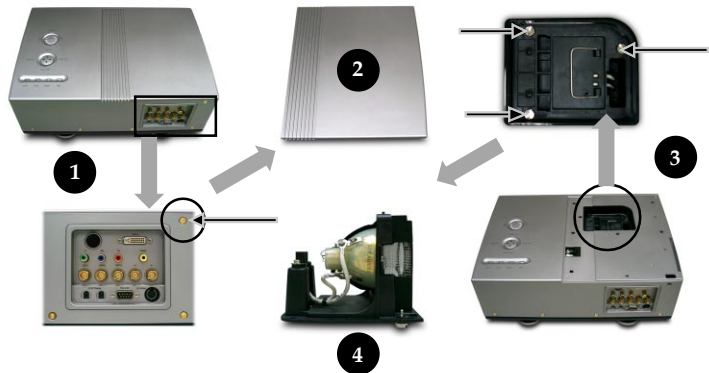

Warning: To reduce the risk of personal injury, avoid dropping the lamp module or touching the lamp bulb. If dropped, the bulb may shatter and cause injury.

Lamp Replacing Procedure:

1. Turn off the power to the lamp by pressing the power button.
2. Allow the projector to cool down at least 30 minutes.
3. Turn off the main power switch.
4. Disconnect the power cord.
5. Use screwdriver to remove the screw on the side of projector as indicated above. ❶
6. Remove the cover. ❷
7. Unscrew 3 screws from the lamp module. ❸
8. Pull out the lamp module. ❹

To replace the lamp module, reverse the above mentioned steps.

Ceiling Mount Installation

1. To prevent damaging your projector, please use the ceiling mount package for installation.
2. If you wish to use a third party ceiling mount kit please ensure the screws used to attached a mount to the projector met the following specifications:

- ▶ **Screw type: M6,M8,M10**
- ▶ **Screw length: 10,16,55 m/m**



❖ Please note that damage resulting from incorrect installation will invalidate the warranty.

